



Features

- Small Body Outline Dimensions
- 358 Watts peak pulse power ($t_p = 8/20\mu s$)
- Protects one I/O or power line
- Low clamping voltage
- Working voltage: 24V
- Low leakage current
- AEC-Q101 Qualified



IEC Compatibility (EN61000-4)

- IEC 61000-4-2 (ESD) $\pm 25kV$ (air), $\pm 20kV$ (contact)
- IEC 61000-4-4 (EFT) 40A (5/50ns)
- IEC 61000-4-5 (Lightning) 5.5A (8/20 μs)

Mechanical Characteristics

- SOD-523 package
- Marking : Marking Code
- Packaging : Tape and Reel
- RoHS Compliant

Applications

- Cellular Handsets & Accessories
- Personal Digital Assistants (PDAs)
- Notebooks & Handhelds
- Portable Instrumentation
- Digital Cameras
- MP3 players

Schematic & PIN Configuration

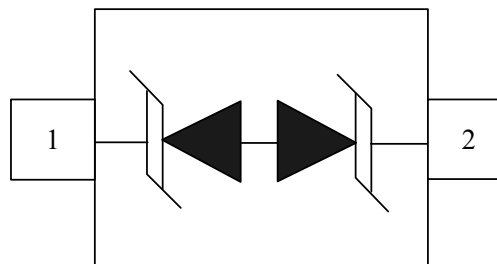

SOD-523 (Top View)

Absolute Maximum Rating			
Rating	Symbol	Value	Units
Peak Pulse Power ($t_p = 8/20\mu s$)	P_{PP}	358	Watts
Peak Pulse Current ($t_p = 8/20\mu s$)	I_{PP}	5.5	A
Operating Temperature	T_J	-55 to +125	°C
Storage Temperature	T_{STG}	-55 to +150	°C

Electrical Parameters (T=25°C)

Symbol	Parameter
I_{PP}	Reverse Peak Pulse Current
V_C	Clamping Voltage @ I_{PP}
V_{RWM}	Reverse Stand-Off Voltage
I_R	Reverse Leakage Current @ V_{RWM}
V_{BR}	Breakdown Voltage @ I_T
I_T	Test Current

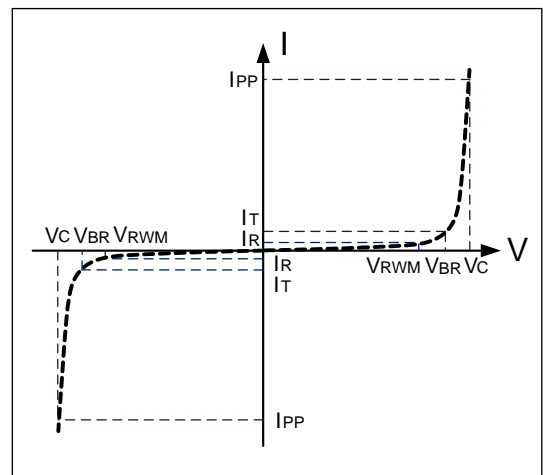

Electrical Characteristics

DW24D5-B-AT-E						
Parameter	Symbol	Conditions	Minimum	Typical	Maximum	Units
Reverse Stand-Off Voltage	V_{RWM}				24	V
Reverse Breakdown Voltage	V_{BR}	$I_T=1mA$	26.7			V
Reverse Leakage Current	I_R	$V_{RWM}=24V, T=25^\circ C$			500	nA
Clamping Voltage	V_C	$I_{PP}=5.5A, t_p=8/20\mu s$		55	65	V
Dynamic Resistance ^{1,2}	R_{DYN}	TLP=0.2/100ns		0.8		Ω
ESD Clamping Voltage ¹	V_C	$I_{PP} = 4A,$ $t_p = 0.2/100ns$ (TLP)		37.5		V
ESD Clamping Voltage ¹	V_C	$I_{PP} = 16A,$ $t_p = 0.2/100ns$ (TLP)		47.2		V
Junction Capacitance	C_j	$V_R=0V, f=1MHz$		12.5	15	pF

Note: 1、TLP Setting : $t_p=100ns, t_r=0.2ns, I_{TLP}$ and V_{TLP} sample window: $t_1=70ns$ to $t_2=90ns$.

2、Dynamic resistance calculated from $I_{PP}=4A$ to $I_{PP}=16A$ using "Best Fit"

Ver.: A1 2019-02-22 WA

Typical Characteristics

Figure 1: Peak Pulse Power Vs Pulse Time

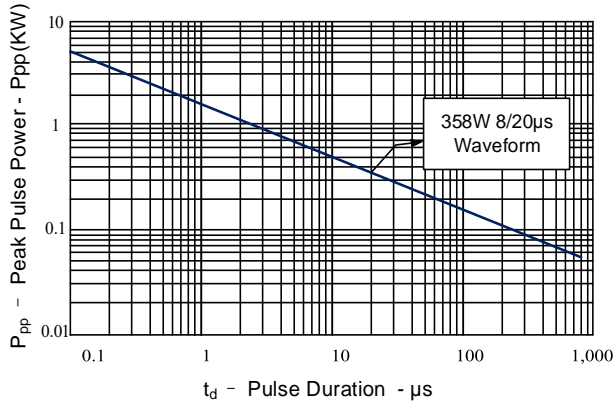

Figure 2: Power Derating Curve

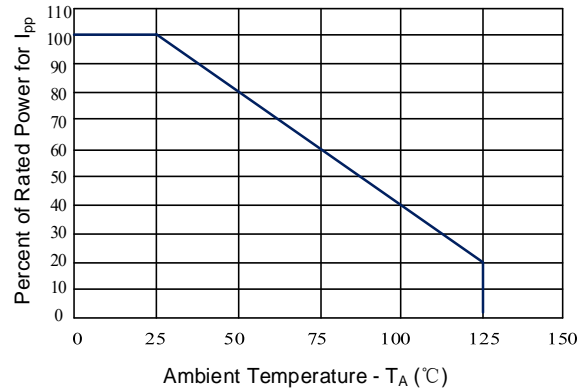

Figure 3: Clamping Voltage vs. Peak Pulse Current

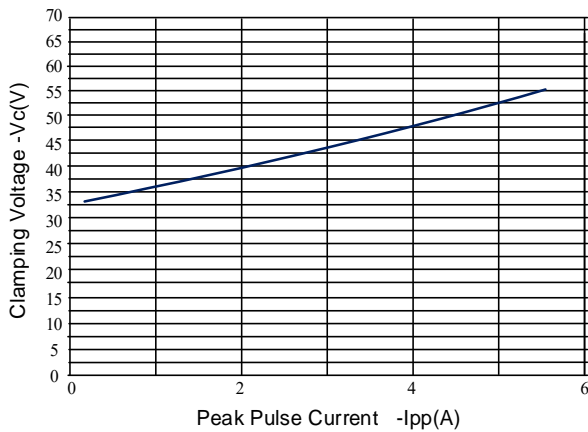

Figure 4: Normalized Junction Capacitance vs. Reverse Voltage

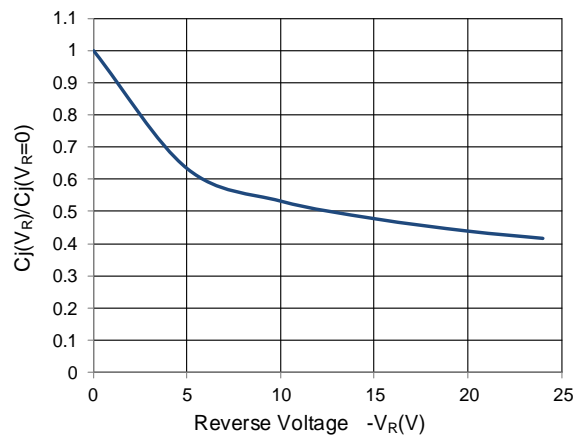

Figure 5: TLP Positive I-V Curve

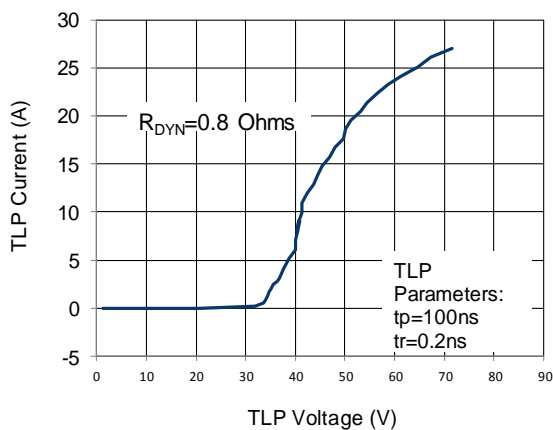
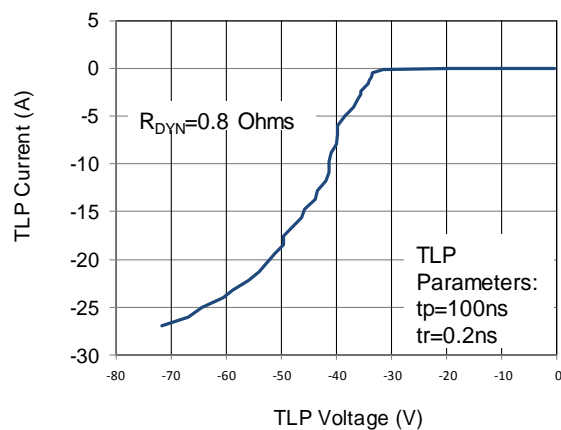
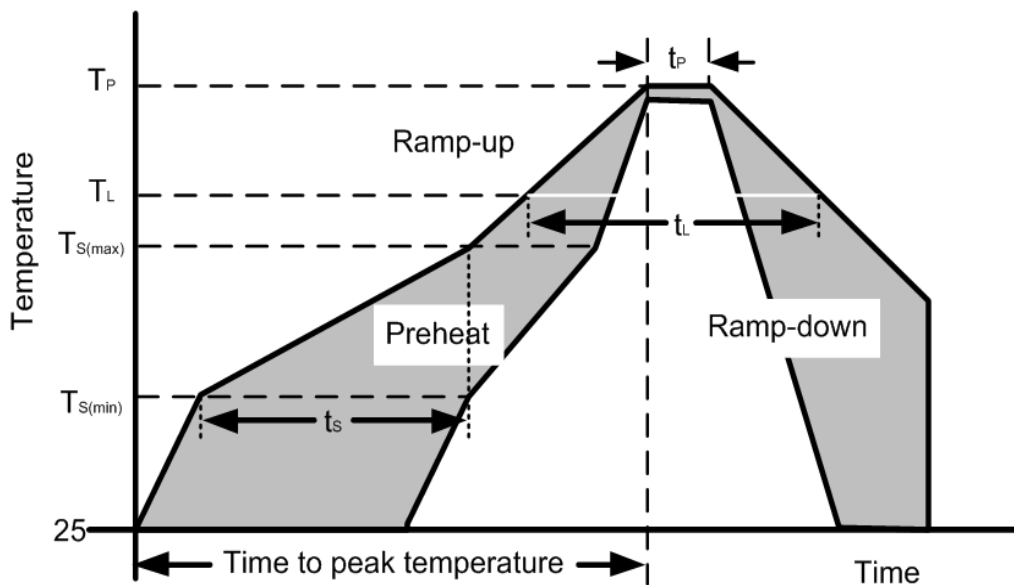

Figure 6: TLP Negative I-V Curve



Soldering Parameters

Reflow Condition		Pb – Free assembly
Pre Heat	Temperature Min ($T_{S(min)}$)	150°C
	Temperature Max ($T_{S(max)}$)	200°C
	Time (min to max) (t_s)	60 – 190 secs
Average ramp up rate (Liquidus Temp) (T_L) to peak		5°C/second max
$T_{S(max)}$ to T_L —Ramp-up Rate		5°C/second max
Reflow	Temperature (T_L) (Liquidus)	217°C
	Temperature (t_L)	60 – 150 seconds
Peak Temperature (T_P)		260+0/-5 °C
Time within actual peak Temperature (t_p)		20 – 40 seconds
Ramp-down Rate		5°C/second max
Time 25°C to peak Temperature (T_P)		8 minutes Max.
Do not exceed		280°C



Outline Drawing –SOD-523

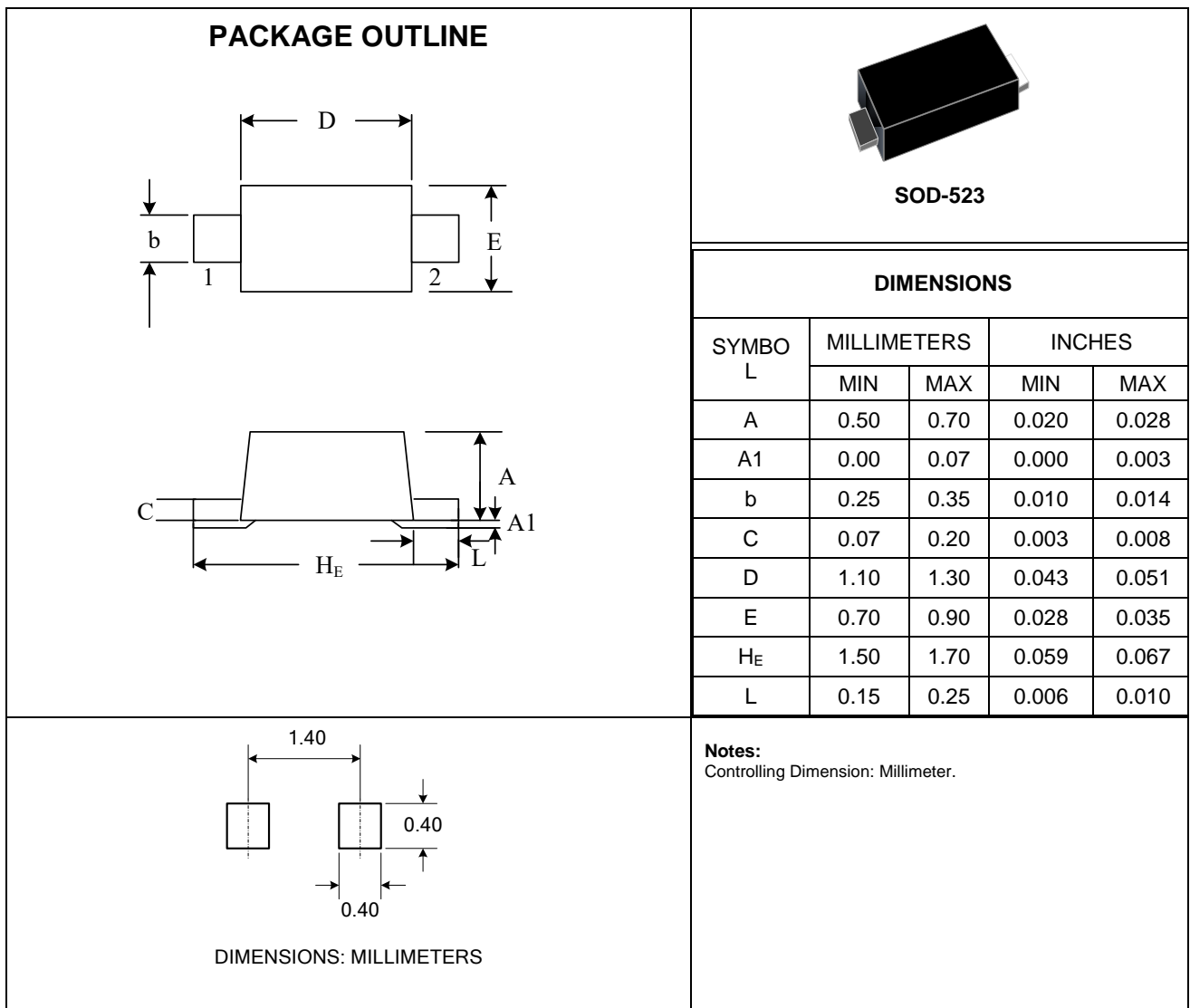

Marking Codes

Part Number	DW24D5-B-AT-E
Marking Code	W5B

Package Information

Qty: 5k/Reel